

theben

EN Presence detector

theRonda P360-330 DALI UP WH
2080045

DALI 307290 02



1. Product characteristics

- Passive infrared presence detector for ceiling installation
- Circular detection area 360° (up to 452 m²)
- Restriction of detection area with cover clips
- Automatic lighting control with constant lighting control or switching operation
- Lighting dimmable in switching operation with or without effect of daylight
- Orientation light (standby function)
- DALI solution for up to 3 flexibly addressable lighting channels
- DALI-2 certified
- Easy, intuitive configuration of DALI groups
- Mixed light measurement suitable for fluorescent lamps (FL/PL/ESL), halogen/incandescent lamps and LEDs
- Adaptable 3-channel light measurement
- Calibration of brightness measurement
- Fully or semi-automatic operation, switchable
- Brightness setpoint value adjustable in lux
- Teach-in function via remote control or button
- Self-learning time delay
- Reduction of time delay when present briefly (short-term presence)
- Detection sensitivity configurable
- 1 presence channel for external DALI relay, e.g. for HVAC control
- Connection option for up to 3 conventional buttons for manual dimming and switching
- Flexible assignment of buttons to required lighting channel by remote control
- Behaviour upon button operation selectable
- Scene functionality
- Easy configuration of the energy-saving response with "eco plus" function
- Test mode for checking function and detection area
- Light test mode for checking the brightness threshold
- Extension of detection area via Master/Slave or Master/Master switching
- Protection rating IP 54 (installed)
- Ceiling installation in flush-mounted box
- Surface mounting on ceilings possible with back box (option)
- Management remote control "SendoPro, theSenda B/ App" (optional)
- User remote control "theSenda S" (option)

2. Safety



WARNING

Danger of death through electric shock or fire!
➤ Installation should only be carried out by a qualified electrician!

- Work on electrical systems may only be carried out by qualified electricians or by instructed persons under the guidance and supervision of a qualified electrician in accordance with the technical regulations applying to electricity!
- Comply with the country-specific safety regulations for work on electrical systems! Ensure absence of voltage in the cable before installation!
- The device is maintenance-free. If the device is opened or penetrated with any object, the guarantee shall lapse.

3. Proper use

The presence detector is intended for indoor installation. The presence detector is exclusively intended for use as contractually agreed between the manufacturer and the user. Any other use is considered to be unacceptable. The manufacturer does not accept liability for any resulting damages.

4. Function

The presence detector is primarily used in offices, schools, conference rooms and corridors, as well as in homes, for easy and energy-efficient control of lighting. The lighting is accordingly influenced by switching or constant lighting control.

Function description

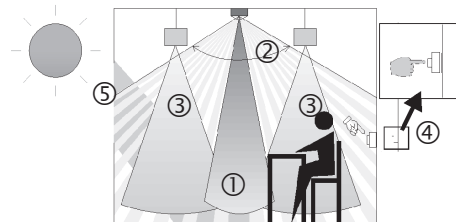

- ① Mixed light measurement
- ② Presence detection
- ③ Artificial light
- ④ Push button for manual lighting control
- ⑤ Incident daylight

Lighting channel C1, C2, C3

The lighting is controlled by presence and brightness. Artificial lighting is switched on and regulated at a constant brightness level via the DALI interface in the event of too little daylight and when the room is occupied.

The lighting is switched off via the DALI interface if there is sufficient daylight or if the room is unoccupied.

Up to 3 lighting groups (lighting channels C1 - C3) can be configured on one single DALI line. DALI devices can be addressed and grouped very easily and intuitively. A detailed description can be found in chapter „9. Start-up“.

Constant light control

Constant light control compensates for variations in daylight by controlling the lighting. The overall brightness will be kept constant at the desired brightness level. The lighting is switched on with the switch-on dimming value and controlled so that it reaches the set brightness setpoint value. Depending on „school“ or „office“ configuration type, the presence detector behaves differently after manual dimming via button:

- „School“ configuration type for applications in classrooms and meeting rooms:
 - Manual dimming deactivates constant light control.
 - Lighting remains at dimmed level when room is occupied (no brightness influence).
 - Switching off and on returns to standard operation.
- „Office“ configuration type for applications in small and large offices:
 - Constant light control remains active temporarily after manual dimming to the current brightness value as the new brightness setpoint value.
 - The new brightness setpoint value only applies if the room is occupied.
 - After the lighting time delay expires, the originally set brightness setpoint value is restored.

Switching operation

Switching response is controlled by presence and brightness. The channel light switches on in darkness and if presence is detected. The light switches off when there is sufficient brightness or once the room is vacated after the set lighting time delay. The light is switched on with the switch-on dimming value. By using the button, the intensity of artificial light can be changed for the duration of the presence. Following override using the button, the light stays on for at least 30 min. The light is forced off after a preset time delay if the room was (previously) vacated.

Standby (orientation light)

The standby function acts as an orientation light. After the lighting time delay expires, the lighting is set to the standby dimming value (1 – 25 %) of the lamp output. The standby time can be set to between 0 s and 60 min or permanently. The lighting is switched off if the brightness level in the room exceeds the brightness setpoint value. The lighting automatically returns to the standby brightness if the room brightness falls below the brightness setpoint value. When the room is entered again, the detector returns to the programmed brightness setpoint value, either automatically (fully automatic device) or after the button is operated (semi-automatic device).

Lighting time delay

The minimum time delay (10 s – 60 min) is adjustable. It adjusts automatically to the user's behaviour and can increase to 30 minutes or drop back to the set minimum time. With settings ≤ 2 min or ≥ 30 min, the time delay remains unchanged at the set value. If someone goes into an unoccupied room only briefly and leaves it within 30 seconds, then the lighting will be switched off prematurely after 2 minutes (short-term presence).

Push button control

The lighting can be manually switched or dimmed at any time at the push of a button. A short press of the button switches the light on or off, a longer press of the button dims the lighting up or down. The dimming direction changes each time

the button is pressed. If the lighting is switched off manually, the lighting will stay off as long as the room is occupied. The lighting switches on again automatically after the time delay has expired. Please pay attention to the differing behaviour of the constant light control and the switching operation, which is described in the corresponding chapter.

Fully or semi-automatic device

Lighting control via the presence detector operates fully automatically for increased comfort or semi-automatically for greater energy savings. The lighting switches on and off automatically as a "fully automatic device". As a "semi-automatic device", the lighting must always be switched on manually. The lighting is switched off automatically.

Exceptionally easy configuration of the energy-saving behaviour

By using the selection "eco" for optimal switching behaviour or "eco plus" for maximum energy savings, users can adjust the presence detector to their needs.

5. Detection area

The circular detection area of the Ronda P presence detector covers a large detection area, and permits a complete room coverage with many applications. Note that seated and walking persons are detected in different areas. The recommended installation height is 2 m – 6 m. As installation height increases, the sensitivity of the presence detector decreases. Walking motions are necessary from installation heights of 3.5 m, and the detection areas of several detectors should overlap in the marginal zones. The detection range is reduced as the temperature increases.

Seated persons:

The presence detector reacts very sensitively to the slightest movements. The information refers to table height (approx. 0.80 m).

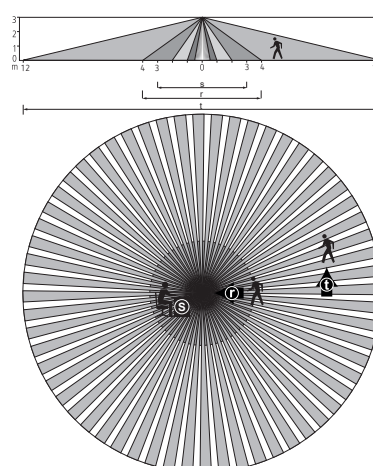

| Installation height (A) | Moving persons Across (t) | | Moving persons Frontal (r) | | Seated persons (s) | |
|-------------------------|---------------------------|--------|----------------------------|-------|--------------------|---------|
| | Area | Ø | Area | Ø | Area | Ø |
| 2,0 m | 380 m ² | Ø 22 m | 28 m ² | Ø 6 m | 16 m ² | Ø 4,5 m |
| 2,5 m | 415 m ² | Ø 23 m | 38 m ² | Ø 7 m | 24 m ² | Ø 5,5 m |
| 3,0 m | 452 m ² | Ø 24 m | 50 m ² | Ø 8 m | 28 m ² | Ø 6 m |
| 3,5 m | 452 m ² | Ø 24 m | 50 m ² | Ø 8 m | 38 m ² | Ø 7 m |
| 4,0 m | 452 m ² | Ø 24 m | 50 m ² | Ø 8 m | – | – |
| 5,0 m | 452 m ² | Ø 24 m | 50 m ² | Ø 8 m | – | – |
| 6,0 m | 452 m ² | Ø 24 m | 50 m ² | Ø 8 m | – | – |
| 10,0 m | 491 m ² | Ø 25 m | 50 m ² | Ø 8 m | – | – |

All figures are guidance values (Detection areas according to sensNORM IEC 63180, see data sheet).

Brightness measurement

The presence detector measures artificial light and daylight by means of three directed light measurements. The central light measurement detects the brightness directly below the detector (A), while the two other light measurements detect the brightness close to the window (B) or in the interior (C). The installation location is the reference point for the lighting level. The brightness measurement can be adapted to the conditions in a room with the room correction factor.

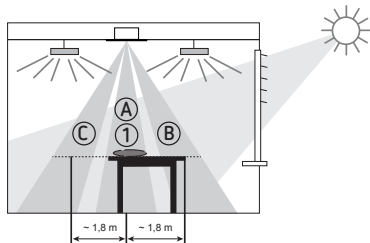

Each light measurement area maps a rectangle of about 2.0 x 3.5 m at table height. Depending on the operating mode, the light measurements are assigned as follows:

- 2-channel: Window light measurement (B) is permanently assigned to lighting channel C1 and interior light measurement (C) to lighting channel C2
- 3-channel: As with 2-channel, but with free choice between central light measurement (A) and integral light measurement (average of light measurements A + B + C) in the case of lighting channel C3

Switching

Direct light influences the light measurement. Avoid placing floor lamps or suspended lighting directly below the detector.

Constant light control

The detector must be positioned in such a way that it only detects artificial light that it controls itself. Artificial light that is controlled by other detectors or manually switched work lighting influence the brightness measurement of the detector. The detector must not be exposed to direct artificial light.

Switching operation

If the brightness measurement is deactivated, the light only comes on when presence is detected (brightness setpoint value set to "measurement off" via the remote control).

Suitable lamps

The presence detector is designed for the operation of fluorescent lamps, compact fluorescent lamps, halogen/incandescent lamps and LEDs.

6. Installation

ⓘ Note window / interior alignment!

Flush-mounted fitting

The presence detector is flush-mounted using a size 1 standard flush-mounting installation socket.

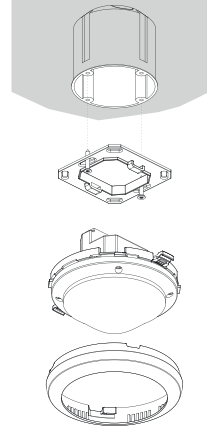

Ceiling installation

A ceiling installation box 73A is available for a simplified ceiling installation of the presence detector (see accessories). This also ensures cord grip and contact protection. The installation diameter is 72 mm (drill diameter 73 mm).

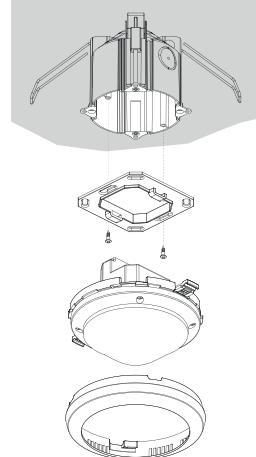

Surface-mounted installation

A back box 110A is available for surface mounted installation (see accessories).

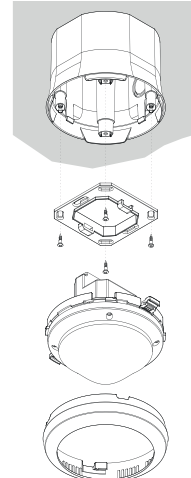

7. Connection

The presence detectors can be combined as master in individual switching, master/master in parallel switching or master/slave parallel switching. Several push buttons can be connected to one control input. Illuminated push buttons can only be used with neutral conductor connection. With the management remote control „SendoPro, theSenda B/App“, lighting channels C1 to C3 can be assigned to the required button inputs S1 to S3 via the parameter <Terminal SX assignment>. The input S3/P can be used for the master/slave parallel signal or master/master switching, or as button input S3. The factory setting is „Parallel“. Up to 50 DALI operating devices can be connected to each master device. We recommend distributing the DALI operating devices equally over the 3 external conductors.

① All detectors and buttons must be connected to the same external conductor.

② Connect at least 1 Dali operating device per master.

Individual switching

In individual switching, the presence detector, as master, detects presence and brightness and controls lighting.

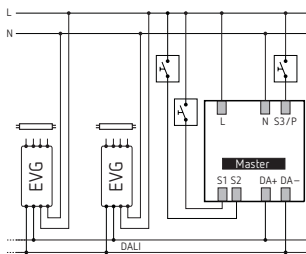

Master/Slave parallel switching

If the detection area covered by one presence detector is insufficient (larger rooms), then up to 10 detectors can be operated in parallel by connecting the P terminals. In the process, presence detection is performed by all detectors together. The master measures the brightness, operates the buttons and controls the lighting. All other detectors are used as slaves. They only provide presence information.

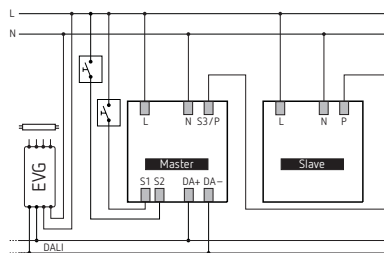

- Light measurement only with the master
- Switch up to 10 detectors in parallel
- Use the same external conductor for all detectors and buttons
- Slave: theRonda P360 Slave (2080080)

Master/master parallel switching

Several masters can be used in parallel switching. Each master controls its lighting groups according to its own

brightness measurements. Time delays and brightness setpoint values are set individually on each master. Presence continues to be detected by all detectors.

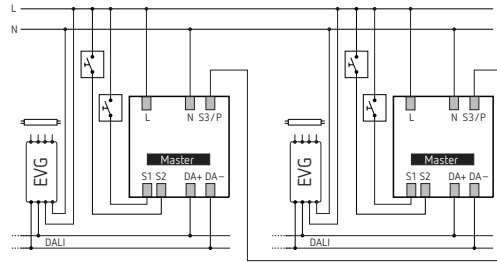

- Master with 2 lighting groups and individual brightness measurement
- Switch up to 10 detectors in parallel
- Use the same phase for all detectors and buttons

Integrating an external DALI relay

- No more than 1 external DALI relay can be connected on one single DALI line. The Dali relay must comply with Standard IEC 62386-208 (device type 7).
- The detector automatically detects the DALI relay.
- Switch-on delay and time delay can be set using the remote control.

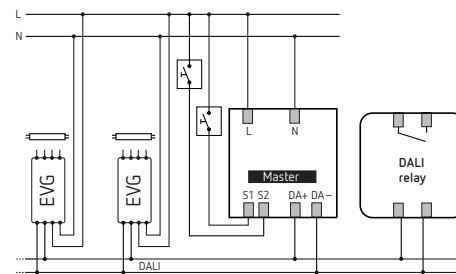

8. Settings

The presence detectors are supplied with basic settings ready for operation. The specifications are guidance values. The optional "SendoPro, theSenda B/App" management remote control or the "theSenda P" installation remote control are available for start-up support. They enable remote setting. The "SendoPro, theSenda B/App" can be used to query, adjust and optimise parameters. With the "theSenda P", parameters can only be adjusted. A range of variable parameters is available for adjustment with the remote control (see section "Parameters via remote control").

Settings via the button

Pressing any button for longer than 15 s triggers the teach-in of the brightness setpoint value by the teach-in function. In addition, the teach-in function can be conveniently executed with the "SendoPro, theSenda B/App" management remote control or the "theSenda P" installation remote control (see section "Control commands via remote control").

The teach-in function via the button can be disabled using the "SendoPro, theSenda B/App" management remote control when the <Configuration button/RC> parameter is set to "disabled".

The lighting groups can also be configured using the buttons. All connected buttons can be used for configuration. A detailed description can be found in chapter „9. Start-up“. Configuration via the buttons can be disabled using the “SendoPro, theSenda B/App” management remote control when the <Configuration button/RC> parameter is set to “disabled”.

Parameters via remote control

The following parameters can be checked or changed via the remote control for support during start-up as well as servicing:

| Parameter | Description | Can be checked SendoPro, theSenda B/App | Can be changed SendoPro, theSenda B/App | Can be changed theSenda P |
|--|---|---|---|---------------------------|
| Function C1 /C2 Function C3 | Selection: switching/control | x | x | |
| Light measurement source C3 | Selection: Centre / Integral | | x | |
| Terminal S1 assignment Terminal S2 assignment | Selection: C1 / C2 / C1+C2 / C3 / C1+C3 / C2+C3 / C1+C2+C3 | | x | |
| Terminal S3/P assignment | Selection: Parallel / C1 / C2 / C1+C2 / C3 / C1+C3 / C2+C3 / C1+C2+C3 | | x | |
| Brightness set point value C1, C2 | Value range in lux/ measurement off | x | x | x |
| Brightness set point value C3 | Value range in lux/ measurement off | x | x | |
| Brightness actual value C1, C2, C3 | Query brightness actual value | x | | |
| Room correction factor Win | Room correction factor on side towards window | x | x | |
| Brightness measurement value Win | Lux meter brightness value on side towards window in lux | x | x | |
| Room correction factor Mid | Room correction factor middle | x | x | |
| Brightness measurement value Mid | Lux meter brightness value middle in lux | | x | |
| Room correction factor Inn | Room correction factor Inn | x | x | |
| Brightness measurement value Ins | Lux meter brightness value interior in lux | | x | |
| Room correction factor Int | Room correction factor Integral | x | x | |
| Brightness measurement value Int | Lux meter brightness value Integral in lux | | x | |
| Detection sensitivity (PIR) | Value range in increments | x | x | x |
| Lighting time delay | Value range in seconds and minutes | | x | x |
| Short presence | Short-term presence: On/Off | x | x | |
| Energy saving mode | Selection: eco/eco plus | x | x | |
| Presence switch-on delay | Value range in seconds/minutes | | x | |
| Presence time delay | Value range in seconds/minutes | | x | x |

| Parameter | Description | Can be checked SendoPro, theSenda B/App | Can be changed SendoPro, theSenda B/App | Can be changed theSenda P |
|------------------------------------|--|---|---|---------------------------|
| Switch-on dimming value C1, C2, C3 | Value range in % | | x | |
| Configuration type C1/C2 | Selection: auto/man | x | x | x |
| Configuration type C3 | Selection: auto/man | x | x | |
| Control speed | Selection: standard/medium/fast | | x | |
| Minimum dimming value | Value range in % | | x | |
| Maximum dimming value | Value range in % | | x | |
| Switching off brightness | Value range in minutes/hours/never off | | x | |
| Manual dimming response | Selection: school/office | | x | |
| Standby time | Value range in seconds/minutes/Permanently on | | x | |
| Standby dimming value | Value range in % | | x | |
| IR group address C1, C2, C3 | Selection: All/I/II/III | | x | |
| Scene 1 C1 Scene 2 C1 | Scene for lighting channel C1 value range in % | | x | |
| Scene 1 C2 Scene 2 C2 | Scene for lighting channel C2 value range in % | | x | |
| Scene 1 C3 Scene 2 C3 | Scene for lighting channel C3 value range in % | | x | |
| Configuration button/RC | Selection: enabled/disabled | | x | |
| LED display motion | Off/On | | x | |

The parameters are sent to the presence detector with the “SendoPro, theSenda B/App” management remote control or with the “theSenda P” installation remote control via infra-red. Changed parameters are applied and used by the detector.

ⓘ Ensure that the parameter selection is limited on the „theSenda P” remote control.

With the “SendoPro, theSenda B/App” management remote control, parameters can be queried by sending values level-by-level to the detector. If the sent value is below the set parameter, the LED illuminates briefly. If the sent value is equal to or above the set parameter, the LED flickers for 2 s.

Function C1, C2

The lighting channels C1 and C2 can be operated together in the switching operation or constant lighting control function. Settings are made via the <Function C1/C2> parameter.

Value range (with SendoPro, theSenda B/App)

| | |
|-----------|---|
| Switching | Lighting channels C1 and C2 are in the switching operating function |
| Control | Lighting channels C1 and C2 light are in the constant lighting control function |

Function C3

Lighting channel C3 can be operated independently from lighting channels C1 and C2 in the switching operation or constant lighting control function. Settings are made via the <Function C3> parameter.

Value range (with SendoPro, theSenda B/App)

| | |
|-----------|--|
| Switching | Lighting channel C3 is in the switching operating function |
| Control | Lighting channel C3 is in the constant lighting control function |

Light measurement source C3

The presence detector measures artificial light and daylight by means of three directed light measurements, see section „Brightness measurement“ on page 3.

In the case of 2-channel operation, the window light measurement (B) is permanently assigned to lighting channel C1 and interior light measurement (C) to lighting channel C2. In the case of 3-channel operation, in addition, the central light measurement (A) or integral light measurement (average of all 3 light measurements) is assigned to lighting channel C3.

Value range (with SendoPro, theSenda B/App)

| | |
|----------|---|
| centre | Lighting channel C3 uses the central light measurement (A), spot metering. |
| Integral | Lighting channel C3 uses the average of all 3 light measurements (A + B + C). |

Terminal S1 assignment, terminal S2 assignment, terminal S3/P assignment

Button terminals S1 and S2 can be assigned to the required lighting channel at any time, without any need for rewiring. Terminal S3/P can be used in two different ways. Either buttons or the parallel signal for master/slave or master/master parallel switching can be connected. The required assignment is carried out via the parameter <Terminal S3/P assignment>.

Value range (with the SendoPro, theSenda B/App)

| Parameter | Master / slave or master / master | Lighting channel | | | | | | |
|--------------------------|-----------------------------------|------------------|----|-------|----|-------|-------|----------|
| | | C1 | C2 | C1+C2 | C3 | C1+C3 | C2+C3 | C1+C2+C3 |
| Terminal S1 assignment | | C1 | C2 | C1+C2 | C3 | C1+C3 | C2+C3 | C1+C2+C3 |
| Terminal S2 assignment | | C1 | C2 | C1+C2 | C3 | C1+C3 | C2+C3 | C1+C2+C3 |
| Terminal S3/P assignment | Parallel | C1 | C2 | C1+C2 | C3 | C1+C3 | C2+C3 | C1+C2+C3 |

Further information can be found in chapter “4 Function”, in the “Lighting channel C1, C2, C3” section on page 1.

Brightness set point value C1, C2, C3

The brightness setpoint value defines the minimum required brightness. The currently prevailing brightness is measured below the presence detector. If the prevailing brightness is below the setpoint value, the light is switched on when a presence is detected (in configuration type fully automatic device).

A separate brightness setpoint value is available for each lighting channel C1, C2, C3.

Value range

- Lux values with “SendoPro, theSenda B/App” management remote control: 10 – 3000 lux, measurement off
- The following values are available with the “theSenda P” installation remote control: 10, 15, 300, 500, 800 lux, measurement off (☼ button), only for lighting channels C1, C2!
- The currently measured brightness value (lux) can be adopted as a new brightness setpoint value with the “SendoPro, theSenda B/App” management remote control by using the teach-in control command, or with the “theSenda P” installation remote control via the teach-in button 👁 (also see table Control commands via remote control). Values outside the permitted range will automatically be set to the appropriate limit value.
- Deactivation of the brightness measurement (the brightness has no effect). The lighting channels only switch after presence/absence. Possible with the «SendoPro, theSenda B/App» management remote control (measurement off) or the „theSenda P” installation remote control (button ☼). With „theSenda P” only lighting channel C1, C2 is possible!

Brightness actual value C1, C2, C3

For monitoring purposes, all 3 brightness actual values can be checked. Checks are described on page 5.

Room correction factor Win, Mid, Inn, Int brightness measurement value Win, Mid, Inn, Int

The room correction factor is a measurement for the difference of the brightness measurement on the ceiling and the work area. The brightness value on the ceiling is influenced by the installation location, the incidence of light, the position of the sun, the weather conditions, as well as the reflection properties of the room and the furniture.

With the room correction factor, the measured brightness value of the corresponding lighting channel is adjusted to the conditions in the room and in this way can be matched to the lux meter value ① measured at the surface beneath the presence detector.

Installation height 3 m

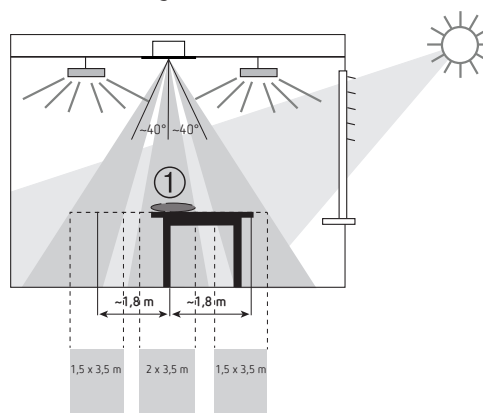

Figure at table height (0.8 m)



$$\text{Room correction factor} = \frac{\text{Brightness value at the ceiling}}{\text{Brightness value on the work surface}}$$

We recommend the following procedure:

- Dim all lights as far as possible. If possible, close blinds.
 - The lux meter is placed on the work surface below the sensor and the measured lux value is entered via the "SendoPro, theSenda B/App" management remote control, <brightness measurement value Win, Mid, Inn, Int> parameter is entered and sent to the detector. During lux measurements, observe the distances shown in the diagram. Carry out all measurements at table height.
 - <Brightness measurement value Win>: Lux measurement towards the window
 - <Brightness measurement value Mid>: Lux measurement in the middle (below detector)
 - <Brightness measurement value Inn>: Lux measurement towards the interior
 - <Brightness measurement value Int>: Average of all 3 lux measurements Win + Mid + Inn.
 - The room correction factor is calculated from this automatically. Values between 0.05 and 2.0 are permitted. Calculated or entered values outside the permitted range will automatically be set to the appropriate limit value.
 - The calculated room correction factor will be applied immediately. For monitoring purposes, the room correction factor can be queried via the <room corr. factor Win, Mid, Inn, Int> parameter.
- ① The standard value is 0.3 and is suitable for most applications. Changes are only sensible in strongly deviating situations.

Detection sensitivity

The detector has 5 sensitivity increments. The basic setting is the middle increment (3).

Increments 1 to 5 can be selected and sent to the detector with the "SendoPro, theSenda B/App" management remote control. On the "theSenda P" installation remote control, the sensitivity can be decreased by one increment each time the button  is pushed or increased with the  button.

Value range



| Increment | Sensitivity |
|-----------|------------------|
| 1 | Very insensitive |
| 2 | Insensitive |
| 3 | Standard |
| 4 | Sensitive |
| 5 | Very sensitive |

By selecting the test presence operating mode, the set sensitivity increment is not changed.

Lighting time delay

The time delay applies jointly to all lighting channels.

Value range

| | |
|---|---|
| Adjustable values with "SendoPro 868-A" management remote control | 10 s – 60 min |
| In the "theSenda P" installation remote control, the following values are available | 10 s (button ) 30 s, 60 s, 2 min, 10 min, 20 min, 60 min (button ) |

Short presence

If someone goes into an unoccupied room only briefly and leaves it within 30 seconds, then the lighting will be switched off prematurely after 2 minutes (short-term presence). The short-term presence can be used for the fully automatic and semi-automatic configuration types.

Value range (with SendoPro, theSenda B/App)

| | |
|--|-----|
| The time delay is applied according to the set time delay. | Off |
| Short-term presence is active. | On |

Energy saving mode eco/eco plus

The selection of "eco" stands for optimum switching behaviour, while "eco plus" stands for maximum energy saving.

Value range (with SendoPro, theSenda B/App)

| | |
|------------|--|
| "eco" | The time delay adjusts to the user behaviour by self-learning. It does not drop below the set value. |
| "eco plus" | The set time delay remains unchanged (no self-learning effect). Faster response to brightness detection than with "eco". |

Presence switch-on delay

The contact of the external DALI relay closes when someone is present regardless of the brightness and after the set switch-on delay has elapsed. Buttons and the configuration type (fully automatic device / semi-automatic device) do not affect the relay contact.

Value range (with SendoPro, theSenda B/app)

| | |
|--------------------|---------------|
| No switch-on delay | 0 s |
| Switch-on delay | 10 s – 30 min |

Presence time delay

The relay contact of the external DALI relay only opens once the set time delay has elapsed in periods of absence.

Value range

| | |
|--|--|
| Adjustable values from SendoPro/theSenda B/app | 10 s – 120 min |
| Adjustable values from theSenda P | 10 s, 30 s, 60 s, 2 min, 10 min, 20 min, 120 min |

Switch-on dimming value C1, C2, C3

The lighting is switched on with the switch-on dimming value in both the switching operation and constant light control.

Value range (with SendoPro, theSenda B/App)

| | |
|------------------------------------|------------|
| Switch-on dimming value C1, C2, C3 | 30 – 100 % |
|------------------------------------|------------|

Configuration type C1/C2

| | |
|---|-------------------|
| Fully automatic device: the lighting switches on and off automatically. (Due to presence, absence and brightness) "SendoPro, theSenda B/App" "theSenda P" | auto Button A |
| Semi-automatic: Lights must always be switched on manually. Lights are switched off automatically by the presence detector. (Due to presence or brightness) "SendoPro, theSenda B/App" "theSenda P" | man Button (L) |

Configuration type C3

Value range (with SendoPro, theSenda B/App)

| | |
|---|------|
| Fully automatic device: the lighting switches on and off automatically (depending on presence, absence and brightness) | auto |
| Semi-automatic: Lights must always be switched on manually. Lights are automatically switched off by the presence detector (due to absence or brightness) | man |

Control speed

In the constant light control function, the speed of the constant light control can be set with the <control speed> parameter.

Value range (with SendoPro, theSenda B/App)

| | |
|--|----------|
| Response is set to its optimum level. The control happens gradually and is almost imperceptible. | Standard |
| The control is slightly faster. | average |
| The control is fast. | fast |

Minimum/maximum dimming value

The upper and lower limits of the output value of all lighting channels can be set with both the <minimum dimming value> and <maximum dimming value> parameters.

Value range (with SendoPro, theSenda B/App)

| | |
|-----------------------|--------------|
| Minimum dimming value | 1 % - 25 % |
| Maximum dimming value | 50 % - 100 % |

Switch-off brightness

In the constant light control function, it is possible to choose to switch the lighting off when there is sufficient brightness. If the lighting is controlled down to the lower limit, the lighting will be switched off after the time set at the parameter <Switch-off brightness>. With the selection "never off", the lighting will never be switched off. This behaviour is valid, as long as people are present.

Value range (with SendoPro, theSenda B/App)

| | |
|---|-------------|
| Switches lighting off after a set amount of time. | 5 min – 9 h |
| Lighting is never switched off. | never off |

Manual dimming response

With constant lighting control, the manual dimming response can be selected with the <manual dimming response> parameter.

Value range (with SendoPro, theSenda B/App)

| | |
|--|--------|
| Constant light control remains active temporarily after manual dimming to the current brightness value as the new setpoint value. After the lighting time delay has expired, the originally configured setpoint value is restored. | office |
| Constant light control is interrupted temporarily via manual dimming. The set point value remains unchanged. | school |

Further information can be found in the chapter "Lighting channel C1, C2, C3 – constant lighting control" on page 2.

Standby time/standby dimming value

When standby time is activated, the lighting is not switched off after completion of the lighting time delay, but remains set to the standby dimming value as an orientation light.

Value range (with SendoPro, theSenda B/App)

| | |
|---|---------------|
| Standby time | 30 s – 60 min |
| Standby function (orientation light) is not active | 0 s |
| Standby function (orientation light) is permanently switched on | on |
| Standby dimming value | 1 – 25 % |

IR group address C1, C2, C3

This parameter is applied when using the "theSenda S" user remote control.





A group address can be assigned to each lighting channel. The "SendoPro, theSenda B/App" management remote control or the "theSenda S" user remote control can be used to program the group addresses in the detector.

Group address value range





| | |
|--|-----------------|
| Adjustable values "SendoPro, theSenda B/App" | I, II, III, All |
| Adjustable values "theSenda S" | I, II |

Using the "theSenda S" user remote control, the group addresses can be assigned as follows:

For IR group address C1:

| | |
|---|----|
| Press the  1 and  1 buttons simultaneously for at least 5 s | I |
| Press the  2 and  2 buttons simultaneously for at least 5 s | II |

For IR group address C2:

| | |
|---|----|
| Press the  1 and  2 buttons simultaneously for at least 5 s | I |
| Press the  2 and  2 buttons simultaneously for at least 5 s | II |



Scene 1 C1, C2, C3 / Scene 2 C1, C2, C3

The desired dimming value for each lighting group can be allocated to scene 1 and scene 2.

Value range (with SendoPro, theSenda B/App)

| | |
|-------------------|-----------|
| Adjustable values | 0 – 100 % |
|-------------------|-----------|

Using the "theSenda S" user remote control, the lighting is firstly set to a desired brightness and then saved as followed:

| | |
|--|------------------|
| Press the  1 button for at least 3 s. | Scene 1 is saved |
| Press the  2 button for at least 3 s. | Scene 2 is saved |

The scene is called up by briefly pressing the button.

Configuration button/RC

The teach-in function and the configuration of lighting groups via the button or the user remote control „theSenda S" can be enabled or disabled with the <configuration button/RC> parameter.

Value range (with SendoPro, theSenda B/App)

| | |
|---|----------|
| Teach-in function and configuration via the button can be executed. | enabled |
| The teach-in function and configuration via the button or the user remote control "theSenda S" is disabled. | disabled |

LED display motion

The motion detection can be displayed via the LED.

Value range (with SendoPro, theSenda B/App)

| | |
|---|-----|
| No display of motion detection. | Off |
| The LED is switched on when motion is detected, otherwise it remains off. | On |

Control commands via remote control

The following control commands can be triggered with the remote control:





| Control command | Description | Can be triggered SendoPro, theSenda B/App | Can be triggered theSenda P |
|--------------------------------|---|---|-----------------------------|
| DALI configuration | Configuration of the lighting groups | | |
| Group assignment (Unaddressed) | Configuration of the unaddressed lighting groups | x | |
| Group assignment (All) | Configuration of all lighting groups | x | |
| Change group assignment | Change configuration of the lighting groups | x | |
| End group assignment | End configuration of the lighting groups | x | |
| Reset DALI ECGs | All connected DALI ECGs are reset to factory settings | x | |
| Reset DALI relay | The connected DALI relay is reset to the factory setting. | x | |
| Switching light C1 | Lighting group C1 can be switched on and off. | x | x |
| Switching light C2 | Lighting group C2 can be switched on and off. | x | x |
| Switching light C3 | Lighting group C3 can be switched on and off | x | |
| Switching light (All) | All lighting groups can be switched on and off together | x | |

| Control command | Description | Can be triggered SendoPro, theSenda B/App | Can be triggered theSenda P |
|-------------------------------|---|---|-----------------------------|
| Teach-in channel C1 | Lighting channel C1 execution | x | x |
| Teach-in channel C2 | Lighting channel C2 execution | x | x |
| Teach-in channel C3 | Lighting channel C3 execution | x | |
| Teach-in channel C1 + C2 + C3 | Activate for all lighting channels C1 - C3 | x | |
| Presence test | On/Off | x | x |
| Light test | On/Off | x | |
| Restart | Restart detector | x | x |
| Factory settings | Set all parameters and settings to factory setting; DALI configuration remains unchanged. | x | |

Teach-in channel C1, C2, C3

During teach-in, the currently measured brightness value is accepted as the brightness setpoint value. Values outside the permitted range will automatically be set to the appropriate limit value.

You can use the „SendoPro, theSenda B/App" management remote control to execute all teach-in control commands. With the "theSenda P" installation remote control, the following teach-in control commands are available.

| | |
|--------------------------|--|
| Teach-in channel C1 | Press the  1 button and then the  button within 10 s |
| Teach-in channel C2 | Press the  2 button and then the  button within 10 s |
| Teach-in channel C1 + C2 | Press the  button |

Presence test

Presence test mode is used to test presence detection and wiring. Presence test mode can be activated with the "SendoPro, theSenda B/App" management remote control or with the "theSenda P" installation remote control ( button). The detector goes directly into test mode when the test mode is set:

- Every movement is indicated by the LED.
- When motion is detected, the lighting is switched on.
- Constant light control is deactivated (switching mode).
- Teach-in cannot be activated in test mode.
- The lighting is switched off after 10 seconds when the room is unoccupied.
- Brightness measurement is deactivated, detector does not respond to brightness.
- Standby function is deactivated.
- The detector reacts as in configuration type "fully automatic device", even if "semi-automatic" is set.
- Test mode ends automatically after 10 min. The detector restarts itself (see switch-on behaviour on page 11).

Light test

The light test mode is used to check the brightness threshold and the constant light control. The light test mode can be

activated with the "SendoPro, theSenda B/App" management remote control. The detector goes directly into test mode when the test mode is set:

- The LED shows the light test mode (5 seconds on, 0.3 seconds off).
- The presence detector responds exactly as in normal operating mode, only the reaction to brightness/darkness is faster.
- In order to simulate this behaviour, either the area below the presence detector can be illuminated or the blinds operated.
- Test mode ends automatically after 10 min. The detector restarts itself (see switch-on behaviour on page 12).

ⓘ Note: Do not use a torch to switch on the presence detector! The adaptive light switching thresholds will be distorted!

Factory settings

The presence detector is supplied with the following parameter values:

| Parameter | Value |
|---|-------------|
| Function C1 / C2 | Control |
| Function C3 | Control |
| Light measurement source C3 | centre |
| Terminal S1 assignment | C1 |
| Terminal S2 assignment | C2 |
| Terminal S3/P assignment | Parallel |
| Brightness set point value C1, C2, C3 | 500 lux |
| Room correction factor Win, Mid, Inn, Int | 0.3 |
| Detection sensitivity (PIR) | Increment 3 |
| Lighting time delay | 10 min |
| Short presence | On |
| Energy saving mode | eco |
| Presence switch-on delay | 0 s |
| Presence time delay | 10 min |
| Switch-on dimming value C1, C2, C3 | 50 % |
| Configuration type C1/C2, C3 | auto |
| Control speed | Standard |
| Minimum dimming value | 10 % |
| Maximum dimming value | 100 % |
| Switching off brightness | 10 min |
| Response after dimming | school |
| Standby time | 0 s |
| Standby dimming value | 10 % |
| IR group address C1 | I |
| IR group address C2 | II |
| IR group address C3 | III |
| Scene 1 C1, C2, C3 | 30 % |
| Scene 2 C1, C2, C3 | 70 % |
| Configuration button/RC | enabled |
| LED display motion | off |

The parameters can only be set to factory settings by using the "SendoPro, theSenda B/App" management remote control.

Reset DALI ECGs

The connected DALI ECGs are reset to factory settings and the group addresses are deleted.

9. Start-up

Initial operation (system not configured)

After first switching on the system power supply, the detector is restarted, automatically identifies all connected DALI lamps, assigns short addresses and manages them in a list. This stage is indicated by an LED flashing pattern (5 x on briefly every 3 s) and, depending on the size of the system, can last up to 3 min.

If no DALI ECG is connected to the detector or a DALI line is interrupted, the detector shows this with the LED flashing pattern (LED is on and flashes off briefly twice every 3 s). If the system is OK, the detector automatically enters configuration mode and waits for configuration of the lighting groups. This is indicated by the LED flashing pattern (2 x on briefly every 3 s). If configuration has not been carried out the system will be in the following operating mode:

- Detector is in broadcast mode.
- Function is switching mode (only presence detection, no light measurement).
- All lights are controlled with 100% switching/dimming value.
- The operating mode is as a fully automatic device.
- All connected buttons are active. It is possible to switch on and off, as well as dim.
- Time delay 10 min.

Configuration of the lighting groups

For the configuration, several options are available:

- Using the service remote control „theSenda B/App“
- Using the management remote control „SendoPro 868-A“
- Using the buttons or „theSenda S“ user remote control

Configuring the lighting groups with the theSenda B/app service remote control

- Connect the theSenda B with the corresponding „theSenda Plug“ app.
- Place the theSenda B under the detector (direct the remote control towards the detector).
- Select „theRonda P360-330 DALI“ as the type in the „theSenda Plug“ app.
- In the „DALI configuration“ menu, select the required group assignment.

For the DALI configuration, there are 3 options available:

- „Group assignment (unaddress.)“: only DALI EBs without a group address are processed.
- „Group assignment (all)“: all connected DALI EBs are configured. WARNING: All existing group assignments with group number 1, 2 or 3 will be deleted.
- „Change group assignment“: the next existing EB is searched for and selected.

ⓘ The remote control must be directed to the detector! The LED is switched off.

→ After selecting the required group assignment, the detector is in the programming mode.

→ A DALI light starts to pulse (random order).

- Use the button # to assign the required C1, C2 or C3 channel to the DALI EB.

→ The lamp confirms the assignment by dimming to 20 %.

- The next DALI light starts to pulse. One after the other, the lighting groups are assigned to all the lights.
- In the case of group assignment (Unaddressed) or (All): When all DALI-ECGs have an assigned lighting group, the detector automatically ends configuration and restarts itself, see section „Switching behaviour“. Finally, the Ronda DALI enters normal operation and configuration is complete.
- If necessary, the configuration process can be ended by pressing „End Group Assignment“ (left function button). In this case, the system is not ready for operation.
- If „Change group assignment“ has been selected, use the „Next“ button (button below) to switch to the next DALI EB without changing the lighting group. Otherwise, the sequence remains the same. When all desired changes have been made, the configuration can be completed by pressing „End“ (button below).

Configuration of the lighting groups by management remote control „SendoPro 868-A“

- On the management remote control „SendoPro 868-A“, select type „theRonda P360-330 DALI“.
- Select „Menu“ (right-hand function button) and then „Control commands“ (left-hand function button).
- Open „DALI configuration“ with „Open“ (right-hand function button).

For the DALI configuration, there are 3 options available:

- „Group assignment (unaddressed)“: Only DALI ECGs without a group address are processed.
 - „Group assignment (All)“: All connected DALI ECGs are configured. **WARNING:** All existing group assignments with group number 1, 2 or 3 will be deleted.
 - „Change group assignment“: The next available ECG will be searched for and selected.
- Select the desired group assignment using the off or on button and start configuration by pressing „Send“ (right-hand function button).
 - ① The remote control must be pointing at the detector! The LED is switched off.
 - A DALI lamp starts to pulse (random order).
 - Select the desired channel C1, C2 or C3 and assign to the DALI ECG by pressing „Send“ (right-hand function button).
 - The lamp confirms the assignment by dimming to 20 %.
 - The next DALI lamp starts to pulse. In this way, all of the lights are assigned to the lighting groups successively.
 - In the case of group assignment (Unaddressed) or (All): When all DALI-ECGs have an assigned lighting group, the detector automatically ends configuration and restarts itself, see section „Switching behaviour“. Finally, the Ronda DALI enters normal operation and configuration is complete.
 - If so required, the configuration can be completed by pressing „End“ (left-hand function button). In this case, the system will not be ready for use.

- If „Change group assignment“ is selected, the right arrow button „>“ can be used to switch to the next DALI ECG without changing the lighting group. Otherwise, the sequence remains the same. When all desired changes have been made, the configuration can be completed by pressing „End“ (left-hand function button).

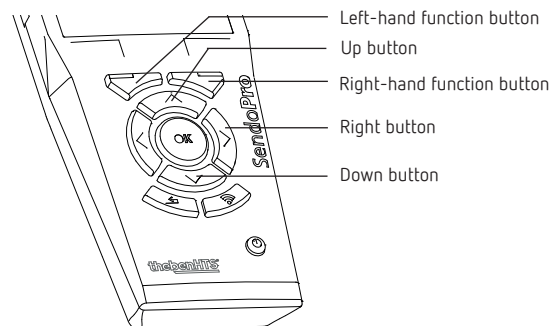

Configuration of the lighting groups using buttons

For the configuration using buttons, the <Configuration button/RC> parameter must be set to „enabled“. All connected buttons can be used for configuration.

- ① If button S3 is used, the <Terminal S3/P assignment> parameter may not be set to „Parallel“.
 - DALI configuration is started by briefly pressing any button 5 x (<0.4 s) followed by 1 x long press (> 15 s). The LED is switched off.
 - A DALI lamp starts to pulse (random order).
 - The lighting group is assigned by pressing the corresponding button:
 - 1 x short button push = Channel C1
 - 2 x short button push = Channel C2
 - 3 x short button push = Channel C3
 - The lamp confirms the assignment by dimming to 20 % (3 s after the last button push).
 - The next DALI lamp starts to pulse. In this way, all of the lights are assigned to the lighting groups successively.
- When all DALI-ECGs have an assigned lighting group, the detector automatically ends configuration and restarts itself, see section „Switching behaviour“. Finally, the Ronda DALI enters normal operation and configuration is complete.
- If so required the configuration can be ended by pressing any button for longer than 15 s. The detector restarts itself. In this case, the system will not be ready for use and must be reconfigured.
- ① Instead of the button, configuration can also be carried out using the On/Off buttons on the „theSenda S“ user remote control.

Checking the configuration

The lighting group assignment can be checked at any time using the buttons or the „SendoPro, theSenda B/App“ management remote control, in that the individual lighting groups are switched on or off (select the menu „control commands“ on the „SendoPro, theSenda B/App“). If the lighting group needs to be changed on individual DALI ECGs, DALI configuration can be carried out using the „SendoPro, theSenda B/App“ via „Change group assignment“. When using the button, the whole DALI configuration must be carried out again.

① A video on configuration of the lighting groups is available at: <https://www.youtube.com/user/TheThebenAG>

Switch-on behaviour (configured systems)

Every time the power supply is switched on, the presence detector runs through two phases that are indicated by the LED:

1. Start-up phase (30 s)

- The red LED flashes at one second intervals and lighting is switched on with switch-on dimming value.
- The detector does not respond to push-button commands or to the "theSenda S" user remote control.
- The lighting is switched off after 30 s when the room is unoccupied.

2. Operation

- The red LED is off. The constant light control or switching mode are started.
- The detector is ready for operation.

10. Technical data

| | |
|---|---|
| Operating voltage | 110 – 230 V AC, +10% / -15% |
| Frequency | 50 – 60 Hz |
| Upstream protection device: | 16 A |
| Power consumption (without DALI-ECG) | < 0.4 W |
| Type of installation | Ceiling installation; flush/surface mounted or ceiling installation |
| Recommended installation height | 2.0 – 3.5 m/max. 15 m |
| Minimum height | > 1.7 m |
| Detection area | horizontal 360° |
| Maximum range | Ø 7 m (Mh. 3.5 m) / 38 m ² seated Ø 25 m (Mh. 10 m) / 491 m ² walking |
| Setting range brightness setpoint value | 10 – 3000 lux |
| Lighting time delay | 10 s – 60 min |
| Presence switch-on delay | 0 s – 30 min |
| Presence time delay | 10 s – 120 min |
| Lighting standby time | 0 s – 60 min / permanently on |
| Standby dimming value | 1 – 25 % |
| Control output lighting | 100 mA guaranteed, max. 250 mA, max. 64 DALI operating devices, basic insulation |
| Connection type | Screw terminals |
| Max. cable cross-section | Max. 2 x 2.5 mm ² |
| Size of flush-mounted box | Size 1, Ø 55 mm (NIS, PMI) |
| Protection rating | IP 20 (IP 54 installed) |
| Ambient temperature | -15 °C ... 50 °C |
| CE Declaration of Conformity | This device conforms to the safety regulations of the EMC directive 2014/30/EU and of directive 2014/35/EU. |
| Dali conformity | IEC 62386-101, IEC 62386-103 |

Product overview

| Type of installation | Channel | Operating voltage | Colour | Type | Item number |
|----------------------|---------|-------------------|--------|---------------------------|-------------|
| Ceiling installation | Light | 230 V AC | White | theRonda P360-330 DALI WH | 2080045 |

Troubleshooting

| Fault | Cause |
|---|---|
| Light does not switch on and/or off if presence is detected and in darkness | Brightness setpoint value is set too low; detector set on semi-automatic; light was switched off manually via button or "theSenda S"; person not within detection area; obstruction(s) interrupting detection; time delay set too short |
| Light stays on with detection of presence despite sufficient brightness | Brightness setpoint value is set too high; light was briefly switched on manually via button or with "theSenda S" (wait 30 min in switching operation); detector is in test mode |
| Light does not switch off and/or light switches on spontaneously when no one is present | Wait for time delay (self-learning); thermal sources of interference in the detection area: fan heaters, incandescent lamps/halogen spotlights, moving objects (e.g. curtains hanging in open windows) |
| Push button does not work | Device still in the start-up phase; illuminated button was used without neutral conductor; Push button not fed to the master. <Terminal S3/P assignment> parameter set to "Parallel". |
| Light cannot be switched off with the push button | Push button not fed to the detector. Check wiring to the push button. <Terminal S3/P assignment> parameter set to "Parallel". |
| Lighting does not react | Short circuit or interruption in the DALI bus. Electrical surge in the DALI bus: Disconnect the detector from the supply network for 1 minute (thermal fuse). |
| Error flashing (4 x per second) | Error in self-test; device not properly functional! |
| LED is on and flashes off briefly 2 x every 3 s | Detector does not recognise DALI ECGs. Check DALI connections. At least 1 DALI ECG must be connected to the detector. Short circuit in DALI bus. |
| Master/Slave, Master/Master parallel switching is not working | Detectors and buttons are not connected to the same external conductor. <Terminal S3/P assignment> parameter is not set to "Parallel". |

11. Dimensions diagrams

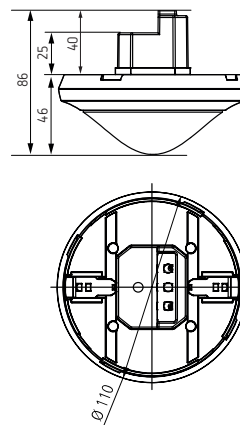

12. Accessories

Back box 110A WH
Item No.: 9070912
[Details > www.theben.de/en](http://www.theben.de/en)

Back box 110A GR
Item No.: 9070913
[Details > www.theben.de/en](http://www.theben.de/en)

DE (ceiling installation) box 73A
Item No.: 9070917
[Details > www.theben.de/en](http://www.theben.de/en)

Cover clip for area restriction
Item No.: 9070921
[Details > www.theben.de/en](http://www.theben.de/en)

theSenda P
Item No.: 9070910
[Details > www.theben.de/en](http://www.theben.de/en)

theSenda S
Item No.: 9070911
[Details > www.theben.de/en](http://www.theben.de/en)

theSenda B/App
Artikel-Nr.: 9070985
[Details > www.theben.de/en](http://www.theben.de/en)

13. Contact

Theben AG
Hohenbergstraße 32
72401 Haigerloch
GERMANY
Tel.: +49 7474 692-0
Fax: +49 7474 692-150

Hotline
Tel.: +49 7474 692-369
hotline@theben.de
www.theben.de

